



2 label options available for the PSD

PSD Strain Gauge or Load Cell Hand Held Display TEDS enabled

User Manual
mantracourt.com

ME mantracourt

What is TEDS?.....	2
Basic concept.....	2
How it works.....	2
Advantages.....	3
Introduction.....	4
User Operation	4
Electrical Connection Information	5
Sensor Connections	5
RS232 Port Connections	5
Internal Connections	5
Menu Structure	7
millivolt per Volt Calibration Menu Structure	9
Configuration Menu.....	10
Calibration Menu.....	12
Millivolt per Volt Calibration Menu	14
Operation Features.....	15
Normal Display Operation	15
Switching the PSD On/Off	15
RANGE Button	15
HOLD Button	16
GROSS/NET Button	16
SHUNT CAL Button.....	16
PEAK Button	16
TROUGH Button	16
Configuration Menu Parameters.....	17
Calibration Menu Parameters.....	19
Calibration Procedures.....	20
Millivolt per Volt Calibration Procedure	22
Specifications.....	23
Mechanical Dimensions	23
Warranty	24

What is TEDS?

"Plug and play sensor hardware and software make configuring a smart TEDS sensor as easy as plugging a mouse into a PC. The technology has greatly improved efficiency and productivity by completely eliminating manual sensor configuration."

Basic concept

TEDS is at the heart of the new universally accepted IEEE 1451.4 standard for delivering Plug and Play capabilities to analogue measurement and test instruments. In essence, information in a Transducer Electronic Data Sheet provides interfacing devices with the critical sensor calibration information in order to perform accurate and precise measurements every time.

TEDS works in a similar way in which USB computer peripherals immediately work as they are connected. TEDS enabled equipment maybe swapped and changed without recalibration, saving time and money.

TEDS holds information such as a sensor manufacturer, model and serial numbers, and more importantly all the calibration settings determined by the manufacturer.

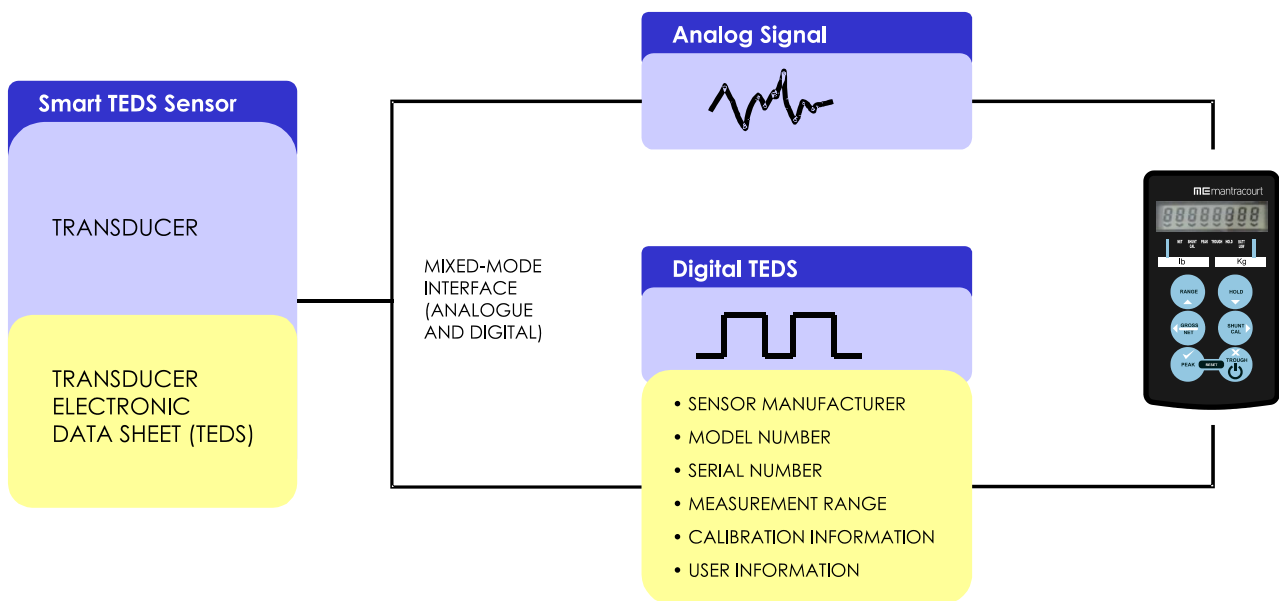

How it works

Plug and play is a data acquisition technology that can simplify the configuration of automated measuring systems by making a sensor's unique identification data available electronically. As implemented according to IEEE P1451.4, data in the form of a transducer electronic data sheet (TEDS) is burned on an electrically erasable programmable read-only memory (EEPROM) chip located on the sensor, so when a properly adapted signal conditioner interrogates the sensor, it can interpret the self identification data. This technology provides a great benefit by eliminating the need for paper calibration sheets. In addition, it can simplify labeling and cabling problems, as well as inventory control issues; by letting you burn location data onto the chip when installing a sensor. And because all sensors produced according to the standard will carry the same basic identically formatted self-identification information, you will be able to mix and match sensors and applicable signal conditioners across manufacturers.

Advantages

Plug and play sensors are revolutionizing measurement and automation. With Transducer Electronic Data Sheets (TEDS), your data acquisition system can detect and automatically configure sensors. This technology provides:

- Reduced configuration time by eliminating manual data entry
- Better sensor tracking by storing data sheets electronically
- Improved accuracy by providing detailed calibration information
- Simplified asset management by eliminating paper data sheets
- Reliable sensor location by identifying individual sensors electronically

Introduction

The PSD Portable Strain Display Load Cell/Force transducer readout is a microprocessor based portable instrument designed to interface with any full bridge sensor with an output sensitivity of up to 50mV/V. Bridge resistances from 85Ω upwards can be used with the PSD.

Configuration and calibration of the PSD is achieved using the front panel push buttons to navigate through a very simple menu structure.

User functions available on the PSD include:-

- Range Selection
- Display Hold/Freeze
- Gross/Net indication selection
- Peak Hold selection
- Trough Hold selection
- Shunt Cal check

The PSD is powered by two internal non-rechargeable AA alkaline batteries.

User Operation



Electrical Connection Information

Sensor Connections

The standard sensor connection is a 5 pin 723 series Binder connector. The wiring for this is detailed below:-

PIN 1	+ve Excitation
PIN 2	-ve Excitation & TEDS Common
PIN 3	+ve Signal
PIN 4	-ve Signal
PIN 5	TEDS

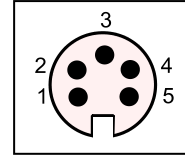

RS232 Port Connections

If the PSD has been ordered with the optional RS232 output, then this will be available via a 8 pin 723 series Binder connector. The wiring for this is as detailed below:-

PIN 1	Tx
PIN 2	Rx
PIN 3	Gnd

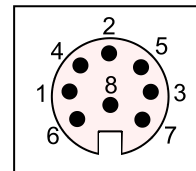







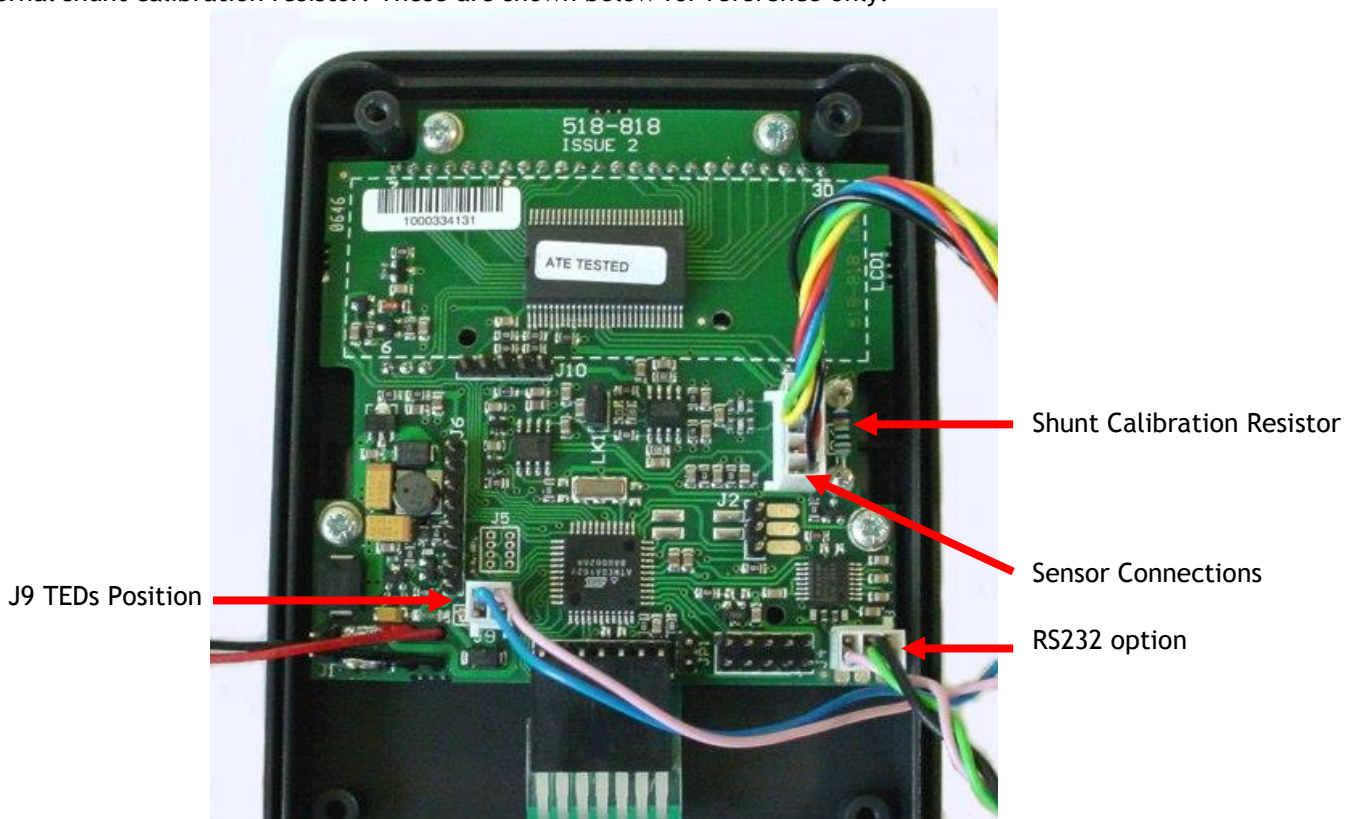

Note: PINS 4 to 8 not connected

Internal Connections

It may be necessary from time to time to know what the internal connections are. For example, if you disturb some of the connections whilst trying to insert the range legends, or if you need to change the internal shunt calibration resistor. These are shown below for reference only:-



There are six push buttons on the front panel of the PSD, which are available for use in normal operation. Each of these is described below:-

Front Panel Button	Function of Button in Normal Operation Mode
	To switch the PSD ON or OFF press and hold the  button
	The RANGE button allows the user to toggle between two independent scales. An annunciator highlights the range that has been selected.
	The HOLD button allows you to hold/freeze the current display value when the button is pressed. Pressing the HOLD button again releases the display. The HOLD annunciator is illuminated when in the HOLD mode, and the display will flash, to alarm further that the user is not viewing instantaneous display values.
	The GROSS/NET button, when pressed, allows the user to toggle between displaying the Gross or Net display values. This can be useful in many applications where it is necessary to display the change in display value from a certain part of the measurement range. When in NET mode the NET annunciator is lit. When in GROSS mode, the NET annunciator is not lit.
	The SHUNT CAL button allows the user to press this at any point in time. The standard unit shunts a 100kΩ resistor across the negative excitation and negative signal connections. If this is performed at the end of the calibration procedure, then a figure can be noted, so the user can check calibration accuracy or connection integrity. The button has to be held down to operate. When held down the SHUNT CAL annunciator is lit and the display will flash, to alarm further that the user is not viewing instantaneous display values.
	When the PEAK button is pressed the display will show the last Peak reading. To reset the Peak readings press the PEAK and TROUGH buttons simultaneously. When in PEAK mode the PEAK annunciator will be lit and the display will flash, to alarm further that the user is not viewing instantaneous display values. To turn off Peak mode press the PEAK button.
	When the TROUGH button is pressed the display will show the last Trough reading. To reset the Trough readings press the TROUGH and PEAK buttons simultaneously. When in TROUGH mode the TROUGH annunciator will be lit and the display will flash, to alarm further that the user is not viewing instantaneous display values. To turn off the Trough mode press the TROUGH button

Menu Structure

The PSD has two menus, details of which are outlined below:-

A CONFIGURATION MENU, which enables the user to tailor the operation to meet a specific application requirement. The values selected in the CONFIGURATION MENU are completely independent for each range.

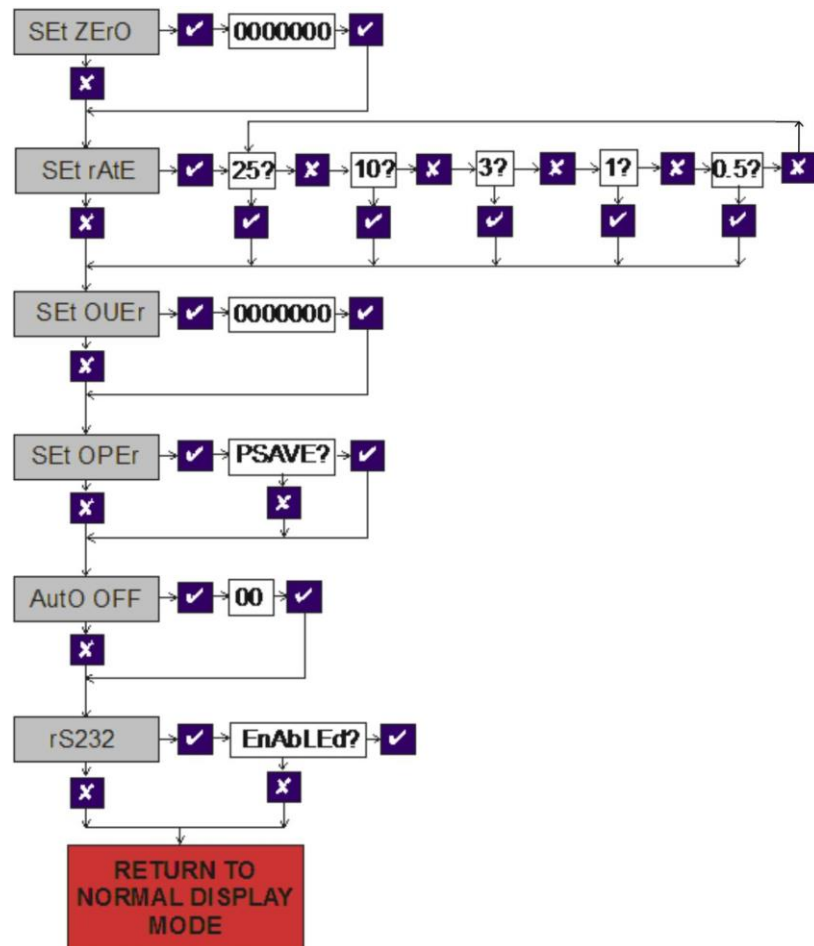

A Calibration Menu, which is used to calibrate each of the two ranges with independent scales, as well as setting the display resolution for each range.

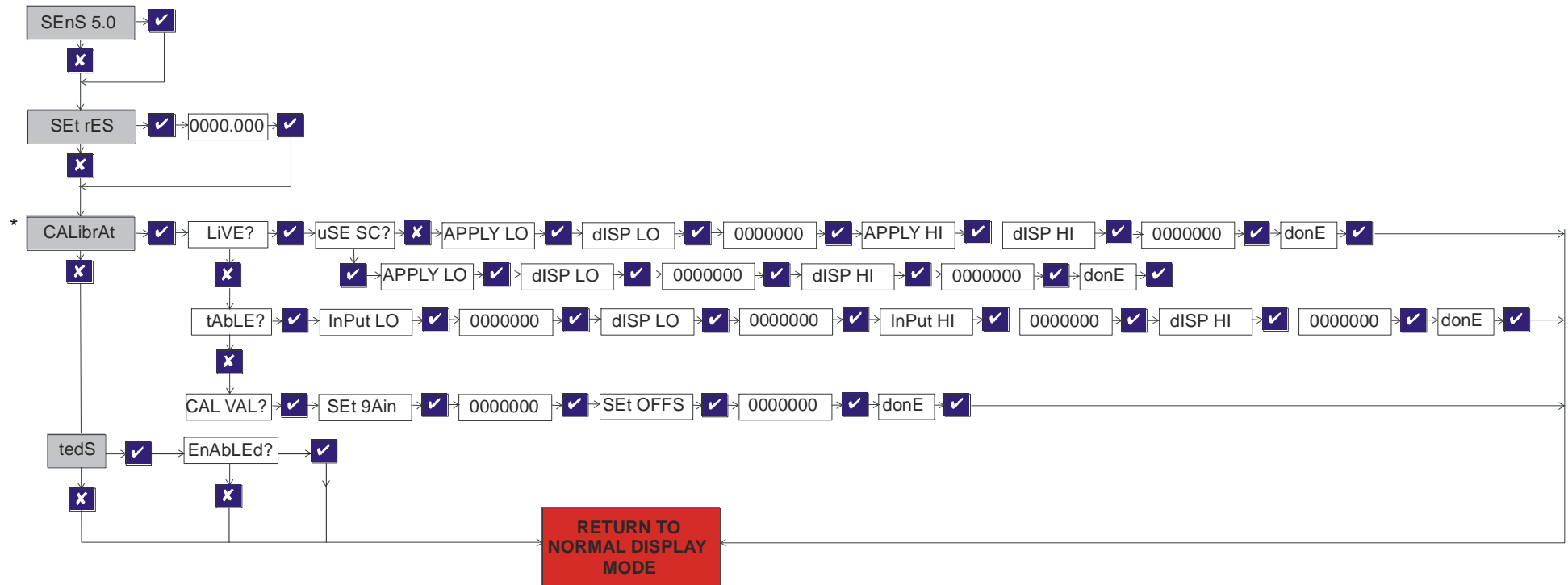

* Note: Only when TEDS is disabled

Millivolt per Volt Calibration Menu Structure

To access the millivolt CALIBRATION MENU,
Press and hold

 and  for 10 seconds

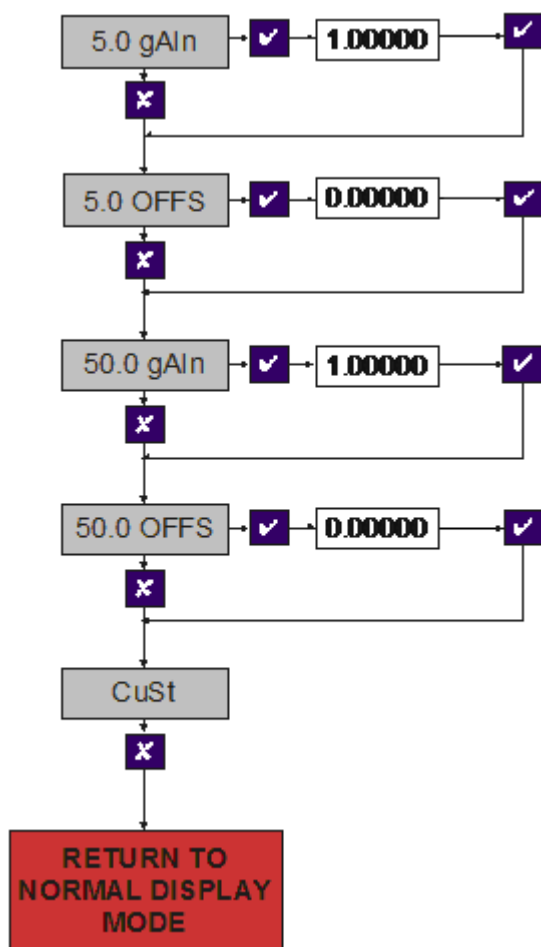

Configuration Menu

To enter the CONFIGURATION MENU, press and hold

















and























buttons for 3 seconds

Parameter	Set-up Information
SEt ZERo	<p>Press To skip to next menu item</p> <p>Press To set a new system zero</p> <p>This allows the user to introduce a fixed offset to the display value. The GROSS and NET values are then displayed with this offset taken into account.</p> <p>Values between -9999999 and +9999999 can be entered, using the and arrows to select a digit and the and arrows to increment or decrement the digits. Press to accept the value and move onto the next parameter.</p> <p>Set Zero may also be set by pressing and at the same time.</p>
SEt rAtE	<p>Press To skip to next menu item</p> <p>Press To change the update rate</p> <p>This allows the user to set the display update rate, the options available is the update rate of the display in Hz. Please note that the 25Hz update is only available in PEAK or TROUGH mode.</p> <p>When you choose to change the update rate you will be prompted whether you want to select 25Hz, if you do not press you will then be prompted to select any of the other values, which in order, are 10Hz, 3Hz, 1Hz, 0.5Hz. to set the update rate for the value you want press </p>
SEt OUEr	<p>Press To skip to next menu item</p> <p>Press To set overload alarm</p> <p>This allows the setting of a visual overload. The value entered is the display value at which the PSD displays OUErLOAd.</p> <p>Values between -9999999 and +9999999 can be entered, using the and arrows to select a digit and the and arrows to increment or decrement the digits. Press to accept the value and move onto the next parameter.</p>

Parameter	Set-up Information
<p>SEt OPEr</p>	<p>Press  To skip to next menu item Press  To select operation mode</p> <p>This allows the enabling or disabling of the power save mode, which updates at 1 update per second and pulses the sensor excitation. This results in a lower accuracy (1 part in 20,000). Minimum bridge resistance is 350Ω for power save mode.</p> <p>To enable press  To disable press </p>
<p>AUto OFF</p>	<p>Press  To skip to next menu item Press  To set auto power off</p> <p>This enables the setting of an auto power off value. The value entered is in minutes. If no front panel buttons are pressed for the time set here, then the indicator will automatically power off, to conserve battery life.</p> <p>Values between 05 and 99 can be entered (between 00 and 04 leaves the PSD permanently powered), using the  and  arrows to select a digit and the  and  arrows to increment or decrement the digits. Press  to accept the value and move onto the next parameter.</p>
<p>rS232</p>	<p>Press  To skip this parameter and exit menu Press  To enable the RS232 output</p> <p>This feature enables you to enable or disable the RS232 output. Further details of the RS232 format are provided further into this manual. The RS232 output is an option that has to be ordered with the PSD. To conserve battery life, it is suggested that the RS232 output is disabled, when it is not required.</p> <p>To enable press  To disable press </p>

Calibration Menu

To enter the **Calibration Menu**, press and hold  and  buttons for 5 seconds

Parameter	Set-up Information
SEnS 5.0	<p>Press  To skip to next menu item</p> <p>Press  To change sensor input sensitivity</p> <p>This allows the calibration engineer to change the sensitivity range of the PSD, when connecting to sensors with a sensitivity of greater than 5mV/V. The PSD is factory set for 5mV/V. To ensure the unit is set to 5mV/V press </p> <p>To select 50mV/V you need to power down the unit and access the internal circuit board. Move link LK1 and place it onto JP1. Power on the PSD and return to this point of the calibration menu. You will notice that the menu parameter has changed to SEnS 50.0, press  to change the sensitivity to 50mV/V and move on to the next parameter.</p>
SEt rES	<p>Press  to skip to next menu item</p> <p>Press  to set the display resolution</p> <p>This parameter sets the decimal point position for the display and the resolution, i.e. a value of 000.005 would display the reading to 3 decimal places and the readings will change in steps of 0.005.</p> <p>The decimal point position is moved one place to the right each time you press the  and  together.</p> <p>Any value can be entered for the resolution, using the  and  arrows to select a digit and the  and  arrows to increment or decrement the digits. Press  to accept the value and move onto the next parameter.</p> <p>To save the settings and move on to the next parameter press </p>
CALibrAt	<p>THIS MENU IS DISABLED WHEN TEDS IS ENABLED</p> <p>Press  to skip to next menu item.</p> <p>Press  to enter the calibration routine</p> <p>If you have chosen to enter the calibration routine you will be prompted whether you want to select LIVE, if you do not press , otherwise press . You will then be prompted to select either of the other calibration methods, which in order, are tABLE and CAL VAL to select any of the calibration methods press . Otherwise press </p> <p>For more detailed calibration information, please refer to the calibration section of the manual.</p>

tedS

ENABLING TEDS DISABLES CALIBRATE MENU

Press to skip this parameter and exit menu

Press to enable or disable TEDS.

If you have chosen to enter the TEDS calibration, **EnAbLEd?** appears.

If you have chosen to enter the TEDS you will be prompted whether you want to select **EnAbLEd?** if you do not press , otherwise press . If you have selected enabled, two flashing indicators will appear.

For more detailed TEDS calibration information, please refer to the TEDS section of the manual.

Millivolt per Volt Calibration Menu

To enter the MilliVolt per Volt Calibration Menu, press and hold



and



buttons for 10 seconds

Parameter	Set-up Information
5.0 gAln	<p>Press To skip to next menu item</p> <p>Press To change the 5mV/V gain.</p> <p>Here the factory gain calibration can be changed to a measured value (see Milli-Volt Calibration Procedure - back end of manual).</p> <p>Once the derived value has been entered Press to confirm.</p>
5.0 OFFS	<p>Press to skip to next menu item</p> <p>Press to change the 5mV/V offset.</p> <p>Here the factory offset value can be changed to a measured value (see Milli-Volt Calibration Procedure - back end of manual).</p> <p>Once the derived value has been entered Press to confirm.</p>
50 gAln	<p>THIS CAN ONLY BE SET WHEN USING 50mV/V RANGE</p> <p>Press To skip to next menu item</p> <p>Press To change the 50mV/V gain.</p> <p>Here the factory gain calibration can be changed to a measured value (see Milli-Volt Calibration Procedure - back end of manual).</p> <p>Once the derived value has been entered Press to confirm.</p>
50 OFFS	<p>THIS CAN ONLY BE SET WHEN USING 50mV/V RANGE</p> <p>Press to skip to next menu item</p> <p>Press to change the 5mV/V offset.</p> <p>Here the factory offset value can be changed to a measured value (see Milli-Volt Calibration Procedure - back end of manual).</p> <p>Once the derived value has been entered Press to confirm.</p>

Operation Features

Normal Display Operation

The PSD has a full 7 digit display, which can be scaled using the calibration menu to suit the application it is to be used in. The display can display the instantaneous, peak or trough values. It is also possible to hold the display value (this only operates when not in peak or trough mode).

The display update rate, decimal point position and resolution can be set to suit.

The PSD has two independent ranges. All values set in one range are totally independent from the other.

Switching the PSD On/Off

The PSD is switched ON or OFF by pressing and holding down the  button for 3 seconds.

It is also possible to set an Auto-off value in the configuration menu, so that the PSD automatically switches itself off after a preset time, if there is no keyboard activity.

RANGE Button

The range feature allows for the setting of two totally independent setup ranges to be selected, if required. To switch between ranges simply press the range button. If TEDS has been enabled then only 1 range is permissible.

When you enter either the calibration menu or configuration menu, the parameters you will be setting are those for the range you have selected. An annunciator is lit to identify which range has been selected.

The PSD is supplied with engineering unit legends; these can be slid into a window, located on the inside of the front panel. These labels then help to further identify the units being displayed for each range. Please refer to the photo below:-

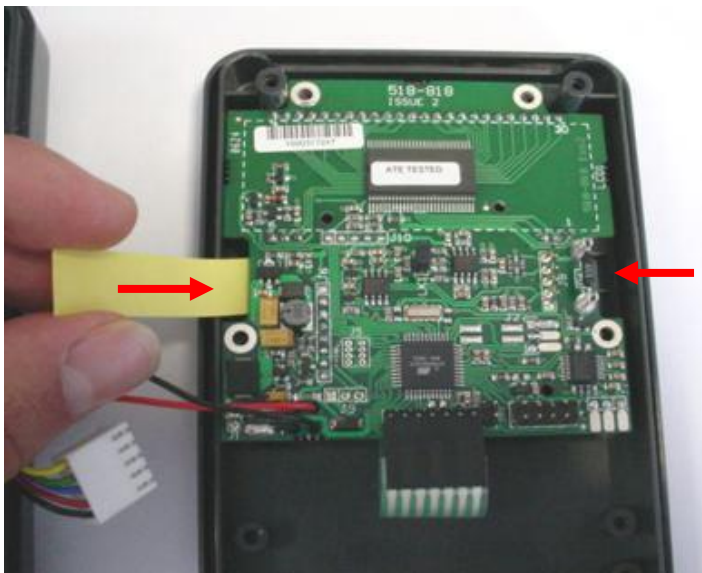

Legend labels are inserted both sides

HOLD Button

The hold button allows the user to freeze the display when it is pressed. When pressed again the display returns to its normal operating mode. When in hold mode the display will flash and the hold annunciator will be lit, to ensure that this feature is not accidentally turned on without the user noticing.

The hold feature can not be used when the PSD is in either peak or trough hold mode.

GROSS/NET Button

The gross/net button, when pressed, toggles between the gross and net display values. This enables the user to zero the display (by putting the PSD into net mode) and displaying the change in display value from that point.

This is useful for certain weighing applications where a tare weight exists, which can be removed by putting the PSD into net mode.

SHUNT CAL Button

The shunt calibration button, when pressed, puts an internal 100kΩ resistor across the -ve excitation and -ve signal of the sensor, generating a simulated output from the sensor, therefore giving a simulated display value. This can be pressed immediately after the sensor has been calibrated with the PSD and noted down for later reference. The value noted can be used to get an idea of the calibration accuracy at a later date, or for checking the integrity of the sensor and sensor cabling.

The shunt calibration resistor can be changed to suit specific requirements. It is suggested that a 15ppm ±0.1% tolerance resistor is used.

PEAK Button

When pressed this button puts the PSD into peak mode. This will display the highest display reading and hold it on the display until it is reset or a higher value is reached. To reset the peak display, press the peak and trough buttons simultaneously. In peak mode it is possible to capture peaks at a rate of up to 25Hz. To turn off the peak mode, press the peak button.

TROUGH Button

When pressed this button puts the PSD into trough mode. This will display the lowest display reading and hold it on the display until it is reset or a lower value is reached. To reset the trough display, press the peak and trough buttons simultaneously. In trough mode it is possible to capture troughs at a rate of up to 25Hz. To turn off the trough mode, press the peak button.

Configuration Menu Parameters

SEt ZERo Parameter

The **SEt ZERo** parameter is meant to be accessible to the user. It allows the removal of fixed display offset values from the display, so that the GROSS and NET features can operate from a zero point. This may also be considered as a manual tare facility. To zero the display, simply enter the value that you wish to subtract from the display in the **SEt ZERo** parameter. i.e. if the display reads 000.103 and you wish it to read 000.000, then enter 000.103 in the **SEt ZERo** parameter.

Set Zero may also be achieved by pressing Gross/Net and Hold button simultaneously.

Different values can be set for each RANGE.

SEt rAtE Parameter

The **SEt rAtE** value sets the display update rate. The options available are 25Hz, 10Hz, 3Hz, 1Hz and 0.5Hz. Different update rates can be set for each RANGE.

The 25Hz rate only updates at this rate when in the PEAK or TROUGH mode. When in normal display mode it has been limited to a 3Hz update, as the digit fluctuations are impossible to view with the human eye.

The 10Hz, 3Hz, 1Hz and 0.5Hz rates update the display every 100mS, 300mS, 1000mS and 2000mS respectively. The PSD when it leaves the factory is set at 3Hz.

SEt OVEr Parameter

The **SEt OVEr** parameter allows the user to set a visual alarm. The value that is entered is the display value that you want the alarm to activate at. When the alarm is activated the word **OVErLOad** appears on the screen. To remove the alarm, the display value must be reduced to a value that is lower than that set in the **SEt OVEr** parameter. This can be very useful as a safety feature, or simply as a quick indication of when a preset level has been reached.

This value entered can be anywhere over the entire display range, so there are no limitations. Different values and settings are available for each RANGE.

SEt OPEr Parameter

The PSD has a special power saving mode, which can be enabled or disabled within this parameter, pressing when asked whether you wish to select **P SAvE?** will put the PSD into power save mode for the RANGE selected. Pressing will de-activate the power save facility.

When the power save facility is activated, battery life is conserved by pulsing on the excitation voltage to the sensor. As a result the accuracy is reduced, as is the update rate. When in this mode, the quickest update rate is 3Hz and the accuracy of the display is reduced to 1 digit in 10,000. It is important to note these limitations when deciding whether to use the power save facility. However, it is also possible to set one RANGE with power save activated and the other without.

The benefit is that the battery life, based on a 350Ω sensor bridge being connected, increases from 45 hours to 450 hours. Power save mode should not be used on sensor bridges of less than 350Ω.

It is also important to remember that when the PSD is re-calibrated with a sensor, the power save facility will be automatically turned off. The power save facility will therefore need to be re-activated after calibration has been completed.

AUtO OFF Parameter

The **AUtO OFF** parameter is another power saving feature. It allows for the setting of a time period in minutes, between 05 and 99 (00 de-activates **AUtO OFF**). i.e. if this was set to 25, then if the PSD detects no keyboard activity for a continuous 25 minute period, then the PSD will power down, to conserve power. If keyboard activity is detected at any time during the 25 minute period, then the time period is restarted.

This can be a useful feature in a site environment, should the PSD be left unintentionally powered on.

rS232 Parameter

This parameter allows the user to enable the RS232 output from the PSD, by pressing when prompted by **EnAbLEd?** On the display, pressing will disable the RS232.

The output format is ASCII. The display value is passed to the RS232 port each time the display updates, with a carriage return and line feed at the end of each data string. The string information is as follows:-

Baud Rate	=	9600 baud
Stop bits	=	1
Parity	=	None
Data bits	=	8

Calibration Menu Parameters

SEnS 5.0 Parameter

The PSD is factory set to enable calibration with sensors generating an input signal of 5mV/V or less. In the majority of cases it will not be necessary to read higher signal levels. If however, a higher sensitivity sensor is used with the PSD, it will be necessary to gain access to the internal PCB (you must turn the PSD off) to move link LK1 to JP1 (see picture below) to allow the PSD to accept sensitivities of up to 50mV/V. TEDS should only be used with 5mV/V as 50mV/V is not factory calibrated.

Once this link has been moved, you will need to go back into the CALIBRATION MENU. When re entering the menu, you will notice that the parameter **SEnS 5.0** has changed to **SEnS 50.0** to change the sensitivity to 50mV/V press , the PSD will now check the position of the link and change the sensitivity. It will now be necessary to re-calibrate any sensors that you may previously have calibrated to this instrument.

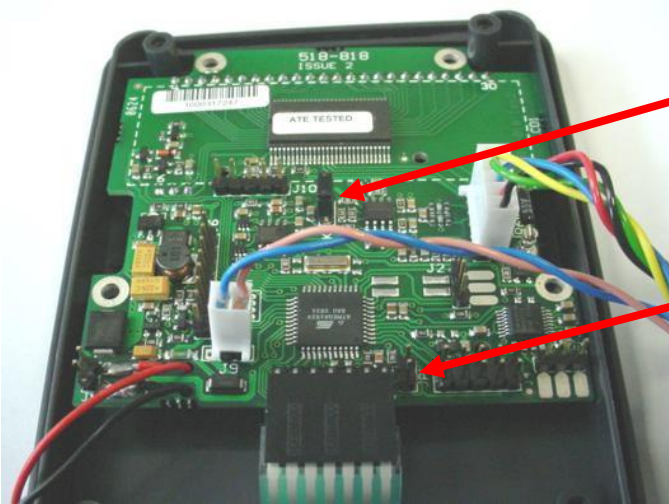

Sensitivity link should be in this position for use with sensors, with sensitivities $\pm 5\text{mV/V}$

Sensitivity link should be in this position for use with sensors, with sensitivities >math>\pm 5\text{mV/V}</math>

SEt rES Parameter

This parameter enables the setting of two features on the PSD. It allows you to set the decimal point position of the display, by pressing the and together, to move the point position (each press moves the decimal point position, one place to the right).

It also allows for the setting of the display resolution or the number of display counts the display changes with an input change. To change the resolution use the and arrows to select a digit you want to change and the and arrows to increment or decrement the digits. Press to accept the value.

CALibrAt Parameter (disabled when TEDS is enabled)

This parameter is used to calibrate and scale the PSD with a sensor. There are two basic methods of calibration available. These are **LIVE** and **tABLE**. There is also a third parameter, which can be used for maintenance and recording purposes. This parameter is **CAL VAL**. The **CAL VAL** value can be viewed after a calibration has been completed and will show the offset and gain figures from any stored calibration. If these figures are noted, they can be used to re-enter at a later date, if calibration data is lost for any reason, or if the calibration data from a sensor needs to be transferred to another PSD.

tedS Parameter

This parameter automatically calibrates the PSD with the data from the TEDS chip. The two annunciators appear when active connection with a TEDS peripheral has been made. When there is a loss of connection these annunciators flash. When changing a sensor the PSD should be power cycled as this is when the TEDS data is read. Calibration Procedures are not available when TEDS is enabled.

TEDS limitations / specifications

ERROR 1 Must be DS2431 or DS2433 Device
ERROR 2 & 3 Must use template 33

Template 33 restrictions

ERROR 6 min physical value = > -9999999.0
 max physical value = > 9999999.0
ERROR 4 value precision case = 1 or 2
ERROR 7 min electrical value > -5.0mV/V
 max electrical value < 5.0 mV/V
ERROR 5 bridge type = FULL (2)

ERROR 8 excitation min = > 5.0
 excitation max = < 5.0

Calibration Procedures

The best method of calibration, if it is possible to do so, is the **LiVE** calibration, as this reads in the sensor signal at two calibration points and scales the PSD automatically. If this is not possible, then the sensitivity figure (in mV/V) from the sensor calibration certificate can be used to scale the PSD, by using the **tAbLE** calibration. This may be the only option available if you are unable to apply a known stimulus to the sensor, which quite often is the case.

LiVE Calibration Procedure

When **CALibrAt** is displayed press

LiVE ? will now be displayed, press

You will be prompted **uSE SC ?**, this can be selected if you wish to use the shunt calibration figure from a sensor calibration certificate (care should be taken that the shunt calibration resistor used originally with the sensor is the same as is fitted in the PSD). If you wish to use this press otherwise press

You will then be prompted **APPLY LO**. At this point ensure that the low calibration stimulus is applied to the sensor and allow to settle of approx. 3 seconds, then press





You will then be prompted with **DISP LO**. Press to enter the display value required with the low stimulus applied to the sensor. The value can be entered by using the and button to select a digit and the and buttons to change the digit. When the value has been set press





You will then be prompted with **APPLY HI** (unless you chose to **uSE SC ?**, in which case jump to the next stage) At this point ensure that the high calibration stimulus is applied to the sensor and allow to settle of approx. 3 seconds, then press

You will then be prompted with **DISP HI**. Press to enter the display value required with the high stimulus applied to the sensor. The value can be entered by using the and button to select a digit and the and buttons to change the digit. When the value has been set press





You should now see **donE** displayed. This means the calibration was successful, press to the PSD to normal operation mode, with the new calibration data stored. If you see **FaiLEd**, then you will need to repeat the calibration, checking that you have completed the procedure in the correct order, and that the sensor is connected correctly.

TABLE Calibration Procedure





When **CALibrAt** is displayed press 
LiVE ? will now be displayed, press 
tAbLE ? will now be displayed, press 
You will be prompted with **InPut LO**, press 

Now enter the 'zero' mV/V output level of the sensor by using the  and  button to select a digit and the  and  buttons to change the digit. When the value has been set press . If you do not know this, simply enter all zeros.

You will be prompted with **DISP LO**. Press  to enter the display value required for the low input figure entered.

The value can be entered by using the  and  button to select a digit and the  and  buttons to change the digit. When the value has been set press 





You will be prompted with **InPut HI**, press 

Now, using the table/value provided by the sensor manufacturer, enter the mV/V output level by using the  and  button to select a digit and the  and  buttons to change the digit.

When the value has been set press 

For example, if you enter a value of 2.5 mV/V for **InPut HI** the display will show '2.500000'

You will then be prompted with **DISP HI**. Press  to enter the display value required for the high input figure entered.

The value can be entered by using the  and  button to select a digit and the  and  buttons to change the digit. When the value has been set press 

You should now see **donE** displayed. This means the calibration was successful, press  to the PSD to normal operation mode, with the new calibration data stored.

If you see **FaiLEd**, then you will need to repeat the calibration, checking that you have completed the procedure in the correct order, and that the sensor is connected correctly.

Millivolt per Volt Calibration Procedure

This procedure outlines how a millivolt per volt calibration might be undertaken.

1. Ensure that the factory settings for gain and offset are set to 1 and 0, respectively. See millivolt per volt calibration section to do this.
2. Begin by connecting up the model PSD and a high precision Multimeter to the calibration source set at 2.5mV/V with a 350Ω load.
3. Take readings at 2.5mV/V and 0mV/V on both the model PSD and the high precision Multimeter.
4. Record your excitation reading.
5. To convert Multimeter reading to a millivolt per volt reading, divide the output reading on the meter by the measured value of excitation.

$$\text{millivolts per volt (mV/V)} = \frac{\text{Output Voltage (mV)}}{\text{Excitation (V)}} \quad [1]$$

6. The gain is then calculated by dividing the difference in the span of the Multimeter readings by The model PSD reading.
7. This value can then be entered into the millivolt per Volt Calibration menu under **5.0 gAIn** then press to confirm.
8. The offset of the model PSD is derived by subtracting the 0mV/V Multimeter reading from the model PSD reading.
9. Again, enter this under **5.0 OFFS** in the millivolt per Volt Calibration menu then press to confirm.



PSD Reading e.g.
 0.000338mV/V @ 0mV/V
 2.47993mV/V @ 2.5mV/V

Calibration Source
 2.5mV/V @ 350 Ω load

Multimeter Reading e.g.
 12.234mV @ 2.5mV/V
 000.001mV @ 0mV/V
 Excitation - 4.8939 V @ 2.5mV/V
 Excitation - 4.8918 V @ 0mV/V

Setup Diagram

Using formula above [1]:

0.000204423mV/V @ 0mV/V
2.499846mV/V @ 2.5mV/V

Worked Example

	PSD handheld (mV/V)	Multimeter (mV/V)
0 mV/V	0.000338	0.000204423
2.5mV/V	2.47993	2.499846

1. Gain = Δ Multimeter reading / Δ PSD reading = $\frac{(2.49984 - 0.000204423)}{(2.47993 - 0.000338)}$ = 1.008008mV/V (6dp)
2. Offset = Multimeter reading - PSD reading = $0.000204423 - 0.000338$ = - 0.000096mV/V (6dp)

Specifications

Performance	Input Type:	Strain Gauge Full Bridge Sensors
	Input Range:	Up $\pm 5\text{mV/V}$ ($\pm 50\text{mV/V}$ can be supplied, with factory set option)
	Non Linearity:	$\pm 50\text{ppm}$ of FR
	Thermal Drift:	$<25\text{ ppm/}^\circ\text{C}$
	Temperature effect on zero (MAX)	$\pm 7\text{ ppm/}^\circ\text{C}$
	Temperature effect on span (MAX)	$\pm 5\text{ ppm/}^\circ\text{C}$
	Offset stability	$\pm 80\text{ ppm}$ of FR*
	Gain stability	$\pm 100\text{ ppm}$ of FR**
	Excitation Voltage:	5Vdc ($\pm 4\%$), 59mA maximum current
	Minimum Bridge Resistance:	85 Ω (4 off 350 Ω sensors in parallel) (350 Ω for power save mode)
Internal Battery:	2off AA size alkaline, access via sealed rear compartment	
Battery Life:	45 hours (Typical 450 hours in low power mode), with 350 Ω sensor	
Update Rate:	Up to 40mS (can be set in configuration menu)	

*from original offset at any time @ 2.5mV/V ** 1st year

Indication	Display Type:	7½ digit LCD display, 8.8mm high digits
	Display Resolution:	1 part in 250,000 at 1Hz update rate 1 part in 65,000 at 10Hz update rate
Control Variables	Annunciators:	Low Battery warning; peak; trough; hold; net; shunt cal; range
	Front Panel User Keys:	Tactile Keys with recessed rims for:- ON/OFF Switches PSD power on/off RANGE Selects between two ranges HOLD Hold the current display value, press again to release GROSS/NET Zero's display ($\pm 100\%$ range) SHUNT CAL Generates simulated input for indicator testing PEAK Enables peak hold TROUGH Enables valley/trough hold
	Settable Parameters:	Tare/Zero value; display resolution/decimal point position; display update rate; low power mode; auto power off;
	Mechanical	Electrical Connection:
	Physical Size:	See drawing below
	Weight:	250 grams
	Legends:	Insert legends for engineering unit identification (supplied)
Environmental	Operating Temperature:	-10°C to $+50^\circ\text{C}$
	Environmental Rating:	IP65 (when mating plug fitted)
	Enclosure Type:	ABS, dark grey (Leather Carry Case Optional)
	European EMC Directive	2004/108/EC BS EN 61326-1:2006 BS EN 61326-2-3:2006

Mechanical Dimensions

The Case is Registered Design No. 3021311

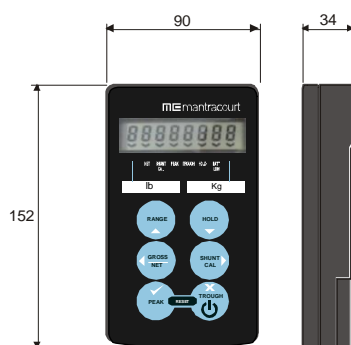

Warranty

The PSD is warranted against defective material and workmanship for a period of (1) one year from the date of dispatch.

If the MANTRACOURT ELECTRONICS LTD' product you purchase appears to have a defect in material or workmanship or fails during normal use within the period, please contact your Distributor, who will assist you in resolving the problem. If it is necessary to return the product to 'MANTRACOURT ELECTRONICS LTD' please include a note stating name, company, address, phone number and a detailed description of the problem. Also, please indicate if it is a warranty repair.

The sender is responsible for shipping charges, freight insurance and proper packaging to prevent breakage in transit.

'MANTRACOURT ELECTRONICS LTD' warranty does not apply to defects resulting from action of the buyer such as mishandling, improper interfacing, operation outside of design limits, improper repair or unauthorised modification. No other warranties are expressed or implied. 'MANTRACOURT ELECTRONICS LTD' specifically disclaims any implied warranties of merchantability or fitness for a specific purpose. The remedies outlined above are the buyer's only remedies. 'MANTRACOURT ELECTRONICS LTD' will not be liable for direct, indirect, special, incidental or consequential damages whether based on the contract, tort or other legal theory.

Any corrective maintenance required after the warranty period should be performed by 'Mantracourt Electronics Ltd' approved personnel only.



In the interests of continued product development, Mantracourt Electronics Limited reserves the right to alter product specifications without prior notice.

Code No. 517-173

Issue 3.1

22.10.14